

Rack200 Rack300



Quick Start Guide

Document Version: v1.3

HAIVISION

Parc Edonia, Bat. X1
Rue de la Terre de Feu
35769 Saint Grégoire Cedex
France
Tel: +33 2 56 56 50 14

Front View

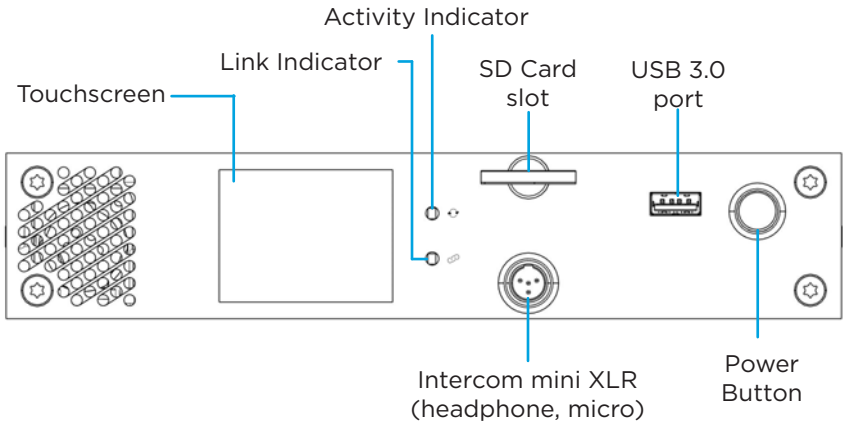

Rear View

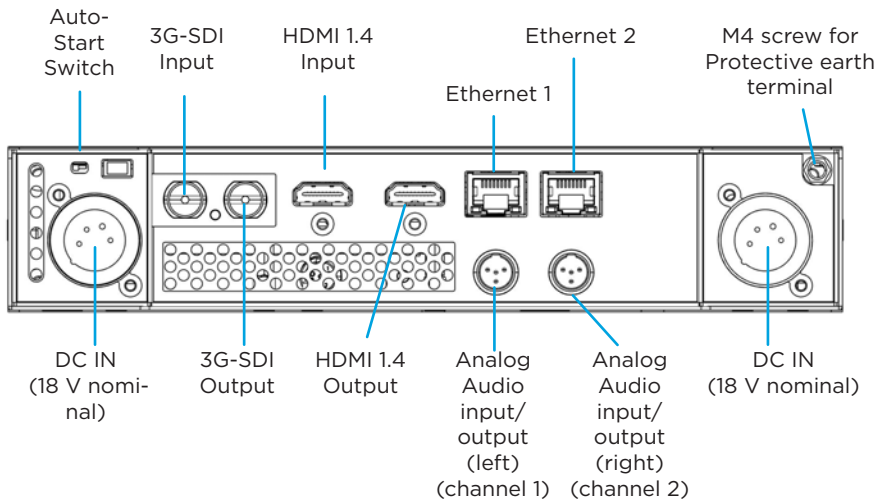

Installing the 1U Mounting Kit

- ✓ Make sure that the unit is turned off and not connected to DC.
- ✓ The following operations require an Allen key 2.5 (not furnished).

1. Unscrew the front panel to take it off.

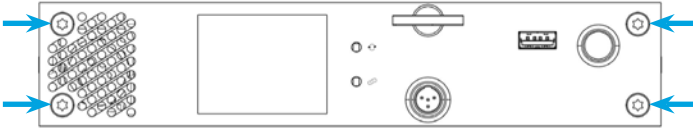

2. Screw the 1U mounting kit to the unit.

- 1U Dual Unit Kit

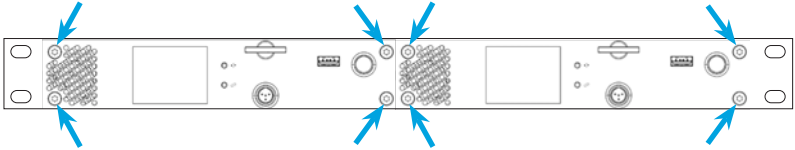

- 1U Single Unit Kit

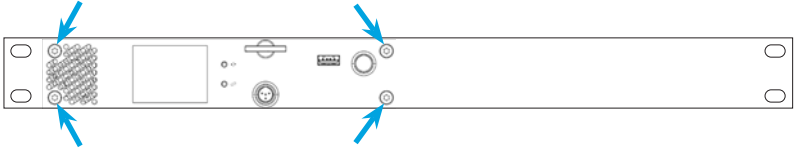

3. Screw the mounted kit to the rack

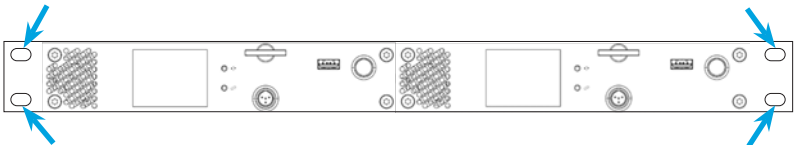

- ✓ It is recommended (but not required) to use horizontal sliders to support the weight.
- ✓ The cooling air flow is from the front panel to the rear panel.

4. Connect the Protective earth terminal.

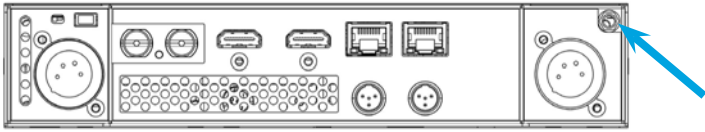

- ✓ The Protective Earth Terminal must be connected to the rack ground pin. This pin must be connected to the safety ground.

Getting ready

1. Connect the AC/DC adapter and the power cable.

- ✓ The unit can operate on a single power supply.
- ✓ It is recommended to connect a second power supply.

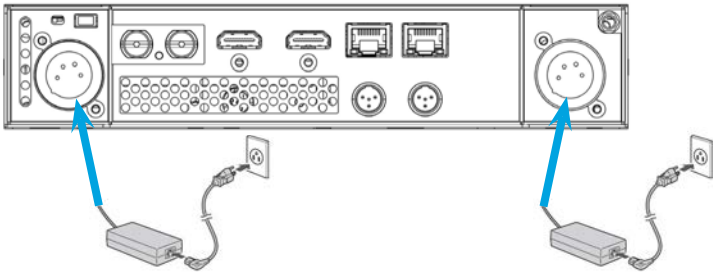

2. Insert a SD card

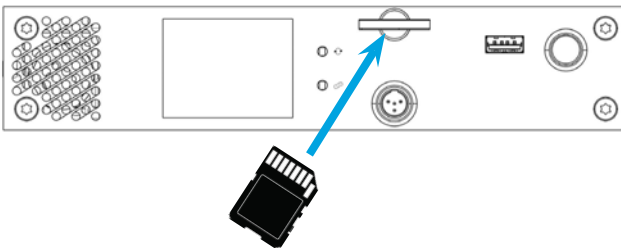

3. Connect the video input cable (either HDMI or SDI).

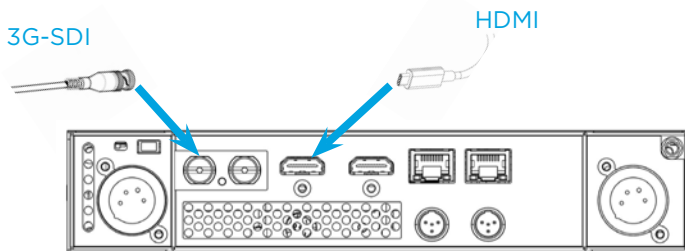

4. Connect the ethernet cable to the ETH1 port.

- The network must have a DHCP server

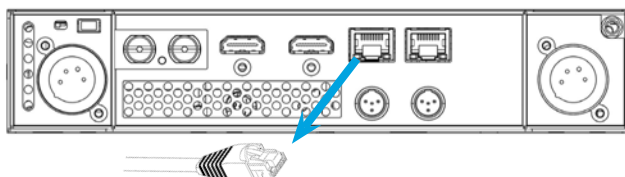

Turning on the unit

1. Press the power button to turn the unit on.

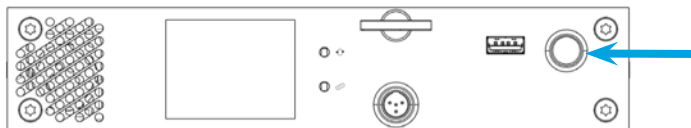

2. When the unit is ready, the Home screen appears:

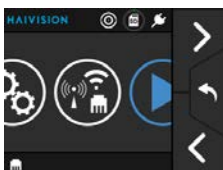

Selecting a Video Source

1. From the Home menu, click on .

2. Click on 
⇒ The default source is Auto.

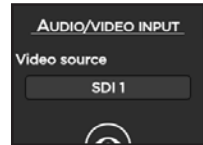

3. Check that video source is Auto.

4. If not (SDI, HDMI or Pattern), click on the Video source Field and select the needed source.

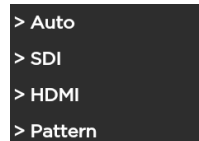

Configuring a Destination Profile

1. Click on  and on  to access the DESTINATION PROFILE CONFIG menu.
⇒ By default no profile exists.



2. Click on  to create a Destination Profile.

3. Click on the Profile Name field.

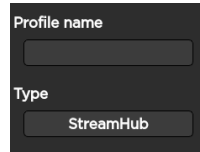

4. Use the keyboard to enter the new profile name.



5. Click on .

6. Click on  to configure the Profile settings:

⇒ Select StreamHub as Host type and set the corresponding IP address.

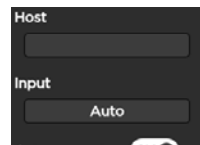

7. Click on  to save the new Destination Profile.

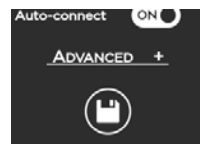

Starting a Live

1. From the Home menu, click on .



2. Click on  to go to the LIVE menu.

The LIVE menu displays information:

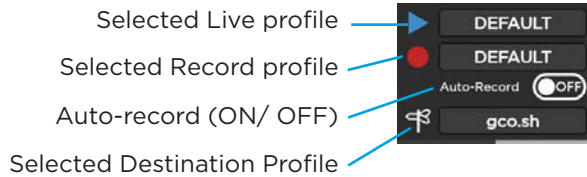

3. Click on  and on  to start a Live.

4. Click on  for more indications.

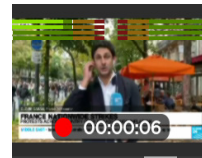

Some indications are displayed:

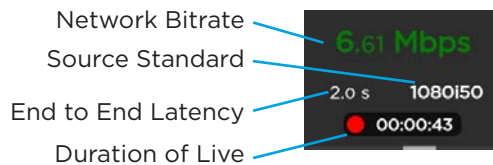



When Auto-record is enabled, additional indications appear:

Remaining Recording

Time possible on SD card

Space used on SD Card

Duration of Live

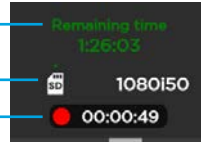

Stopping a Live

1. Click on .

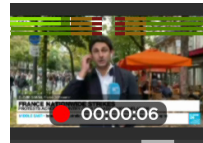

2. Click on .

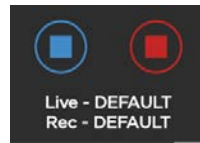

3. Click on .

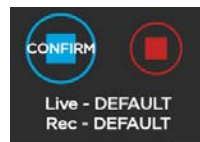

Starting a Record

1. From the Home menu, click on .



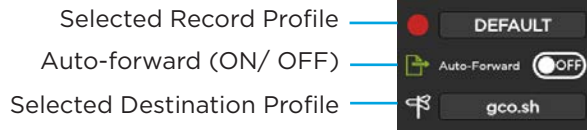

2. Click on  to go to the RECORD menu.

The RECORD menu displays information:

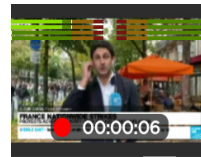

3. Click on  and on  to start a Record.



4. Click on  for more indications.

Some indications are displayed:

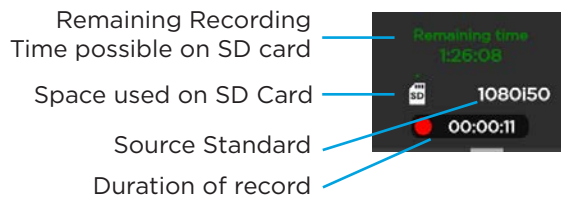



In case of a Record and Forward, additional indications appear:

Network Bitrate — 3.45 Mbps

Amount and percentage of data already forwarded — 9.7 MB - 39%

Duration of record — 00:00:18

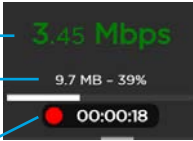

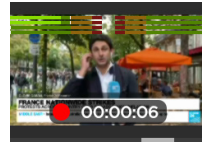

Stopping a Record

1. Click on .

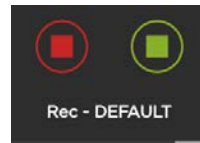

2. Click on .



3. Click on .

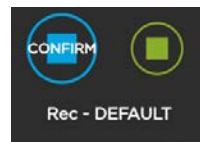

Starting a Forward

1. From the Home menu, click on .

The Forward menu appears:



2. Select a type of Forward.

To forward the last record:

Click on .

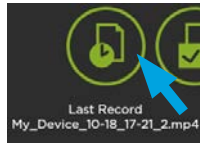

To forward all files:

a) Click on .



b) Click on .

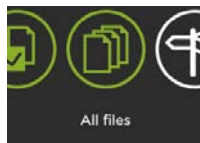

To forward some specific files:

a) Click on .



b) Click on .

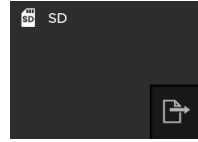

c) Click on files to be forwarded.

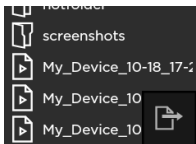

d) Click on .



During forward, some indications are displayed:

Number of files still to be forwarded —

Network Bitrate — **23.8 Mbps**

Amount and percentage of data already forwarded — 10.1 MB - Validating

Duration of forward — **00:00:08**

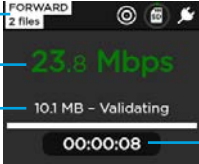

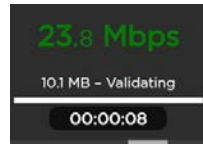

Stopping a Forward

1. Click on .

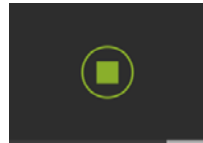

2. Click on .



3. Click on .



Turning off the unit

Long press the power button to turn the unit off.

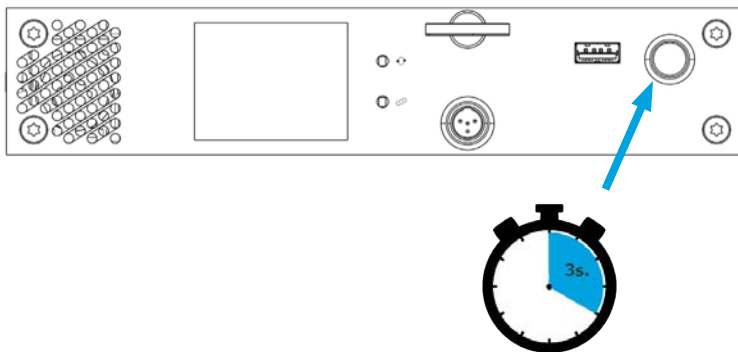

All technical documents

Find the user guide and all other technical documents on Haivision Info Center at <https://doc.haivision.com>.