

# Pro460

---



## Quick Start Guide

Document Version: v1.1

# HAIVISION

Parc Edonia, Bat. X1  
Rue de la Terre de Feu  
35769 Saint Grégoire Cedex  
France  
Tel: +33 2 56 56 50 14



## Front View

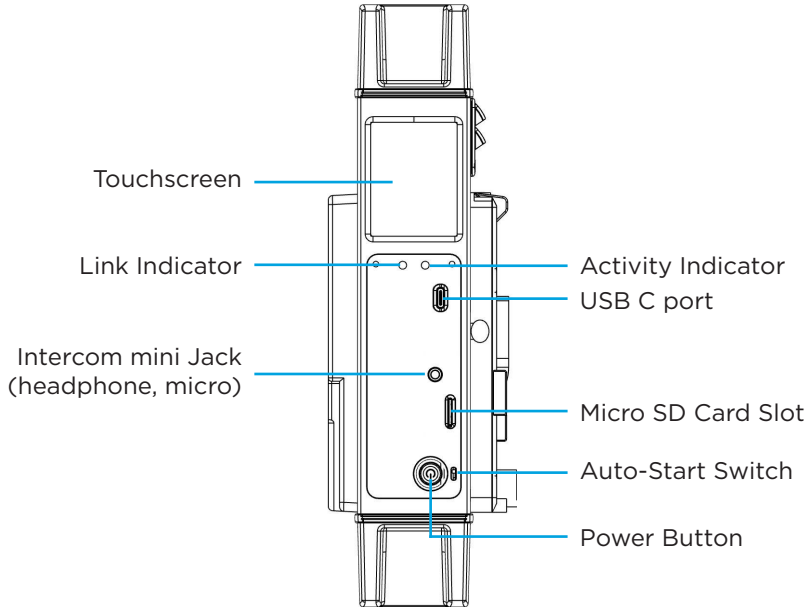

## Rear View

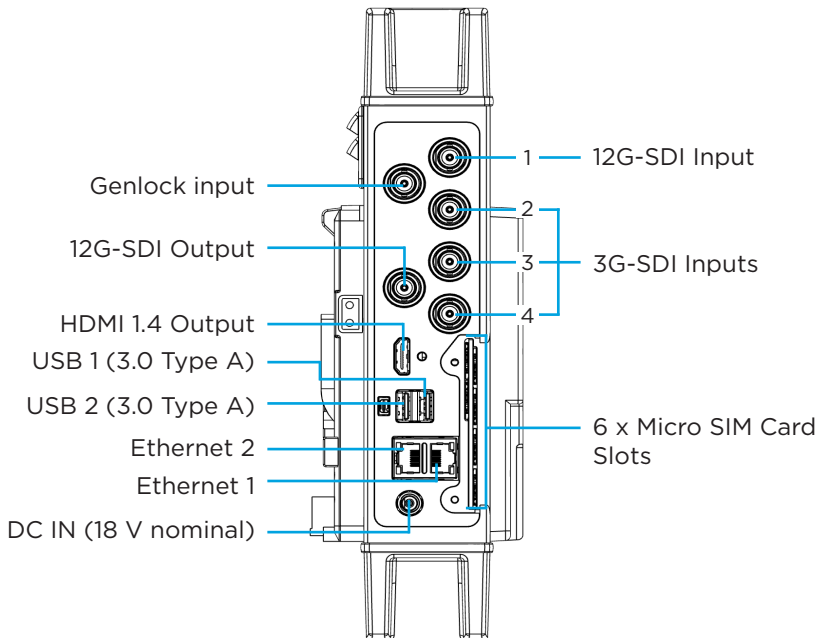

## Left and right sides

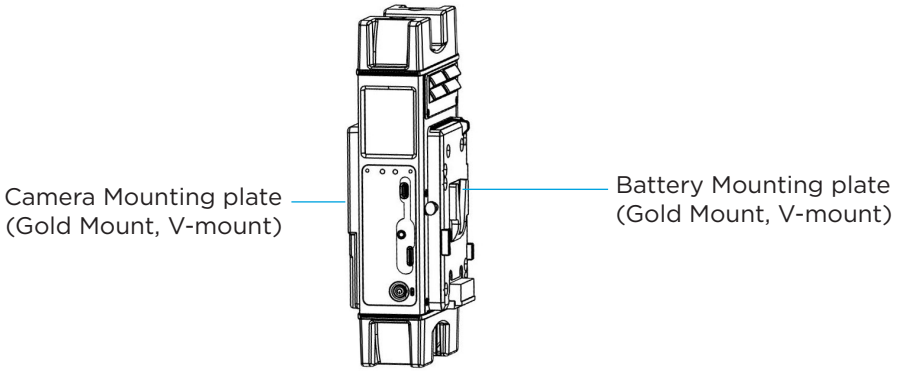

## Getting ready

1. Install an external battery onto the unit or connect the AC/DC adapter to the unit

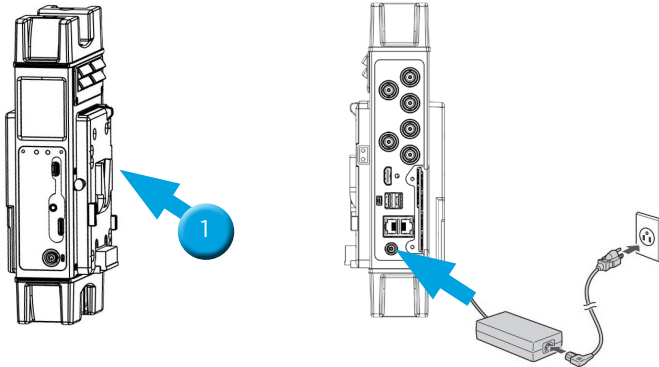

2. Insert a micro SD card

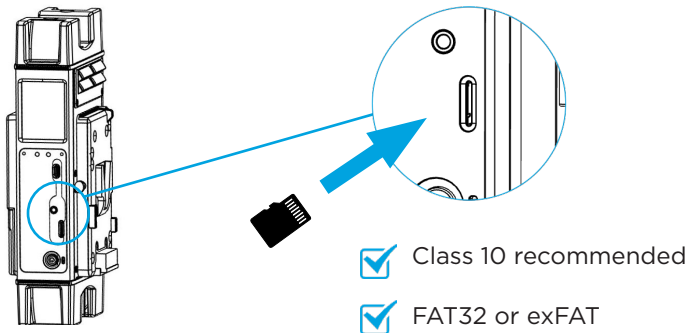

3. Insert SIM cards into slots.

 Micro SIM cards required.

a) Remove the SIM card cover.

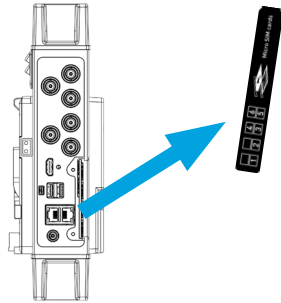

b) Insert SIM cards according to indications on cover.

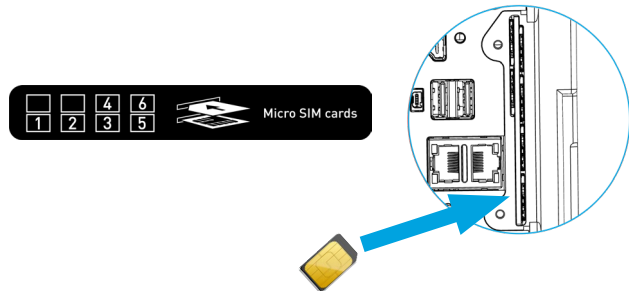

c) Place the rear cover back.

4. Connect the video input cable on SDI 1.

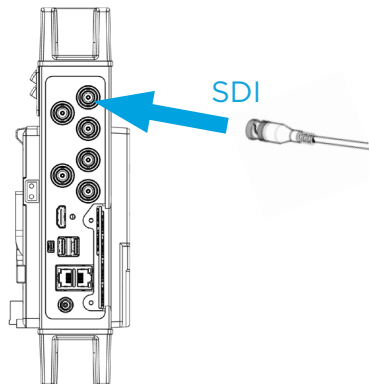

## Turning on the unit

---

Press the power button to turn the unit on.

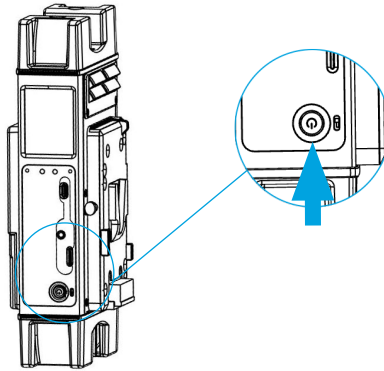

When the unit is ready, the Home screen appears:

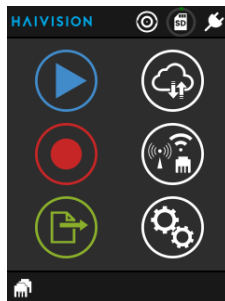

By default, the unit is configured in Single encoding mode (one video source). The following steps are therefore written for this mode. For multi encoding mode (multiple video sources), please refer to the user guide.

## Selecting a Video Source

---

1. From the Home menu, click on .

2. Click on   
⇒ The default source is SDI 1.

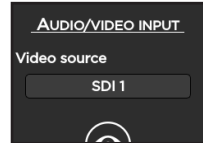

3. Check that video source is SDI 1.

4. If not, click on the Video source Field and select the needed source.

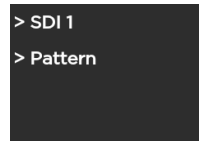

## Configuring a Destination Profile

---

1. Click on  and on  to access the DESTINATION PROFILE CONFIG menu.  
⇒ By default no profile exists.



2. Click on  to create a Destination Profile.

3. Click on the Profile Name field.

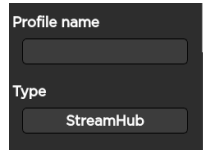

4. Use the keyboard to enter the new Profile name.



5. Click on .

6. Click on  to configure the Profile settings:

⇒ Select StreamHub as Host type and set the corresponding IP address.

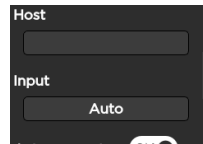

7. Click on  to save the new Destination Profile.

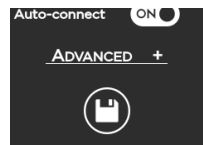





## Starting a Live

---

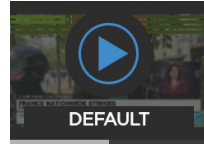
1. From the Home menu, click on .



2. Click on  to go to the LIVE menu.

The LIVE menu displays information:

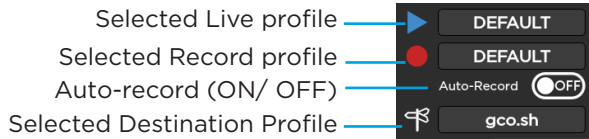

3. Click on  and on  to start a Live.

4. Click on  for more indications.

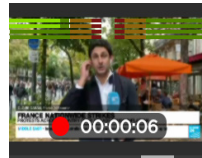

Some indications are displayed:

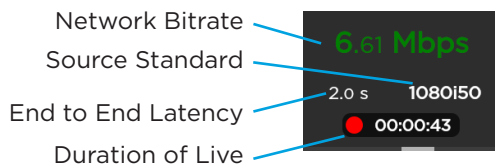



When Auto-record is enabled, additional indications appear:

Remaining Recording  
Time possible on SD card

Space used on SD Card

Duration of Live

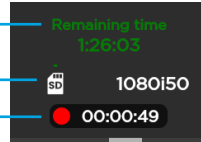

## Stopping a Live

1. Click on

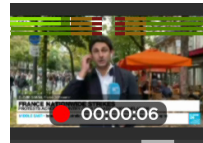

2. Click on

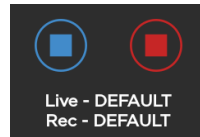

3. Click on

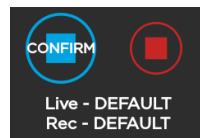

## Starting a Record

---

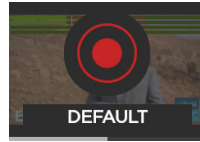

1. From the Home menu, click on .

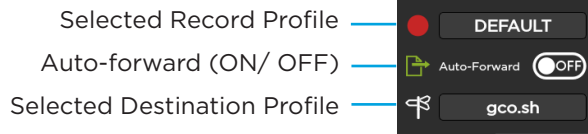

2. Click on  to go to the RECORD menu.

The RECORD menu displays information:



3. Click on  and on  to start a Record.

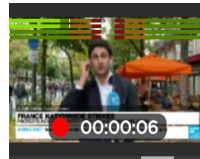

4. Click on  for more indications.

Some indications are displayed:

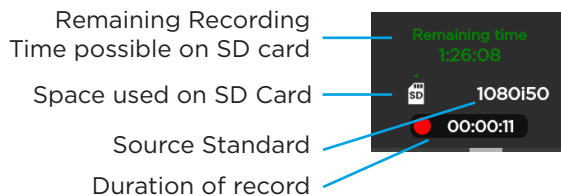



In case of a Record and Forward, additional indications appear:

Network Bitrate — 3.45 Mbps

Amount and percentage of data already forwarded — 9.7 MB - 39%

Duration of record — 00:00:18

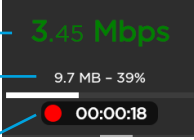

## Stopping a Record

1. Click on .

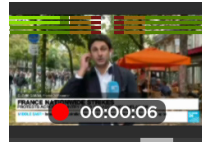

2. Click on .

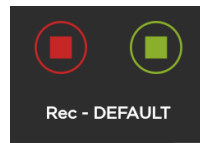

3. Click on .

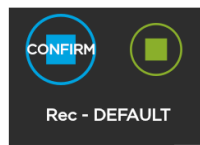

## Starting a Forward

---

1. From the Home menu, click on .

The Forward menu appears:

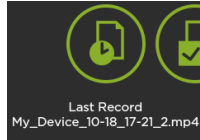

2. Select a type of Forward.

To forward the last record:

Click on .

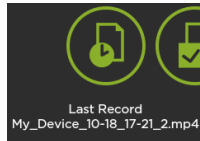

To forward all files:

a) Click on .

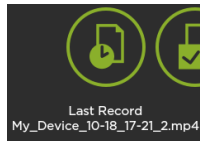

b) Click on .

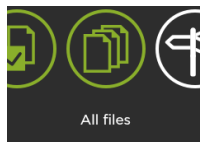

To forward some specific files:

a) Click on .

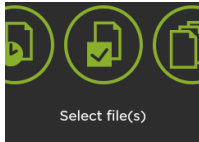

b) Click on .

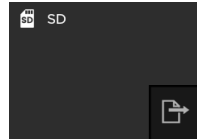

c) Click on files to be forwarded.

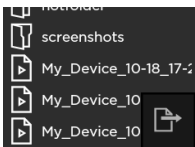

d) Click on .

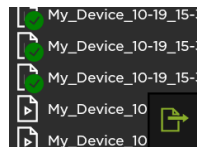

During forward, some indications are displayed:

Number of files still to be forwarded —

Network Bitrate — **23.8 Mbps**

Amount and percentage of data already forwarded — 10.1 MB - Validating

Duration of forward — **00:00:08**

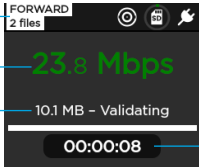

## Stopping a Forward

---

1. Click on .

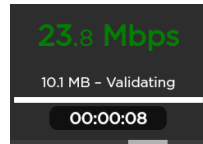

2. Click on .

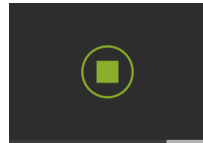

3. Click on .



## Turning off the unit

---

Long press the power button to turn the unit off.

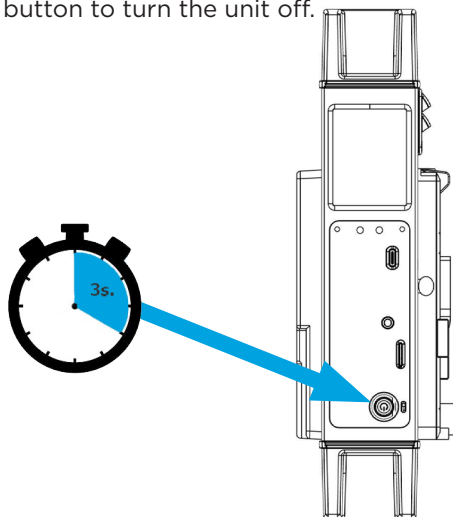

## All technical documents

---

Find the user guide and all other technical documents on Haivision Info Center at <https://doc.haivision.com>.