

# Pro3 Series

---



Pro340



Pro360-5G



Pro380

## Quick Start Guide

Document Version: v1.6

# HAIVISION

Parc Edonia, Bat. X1  
Rue de la Terre de Feu  
35769 Saint Grégoire Cedex  
France  
Tel: +33 2 56 56 50 14

## Front View

---

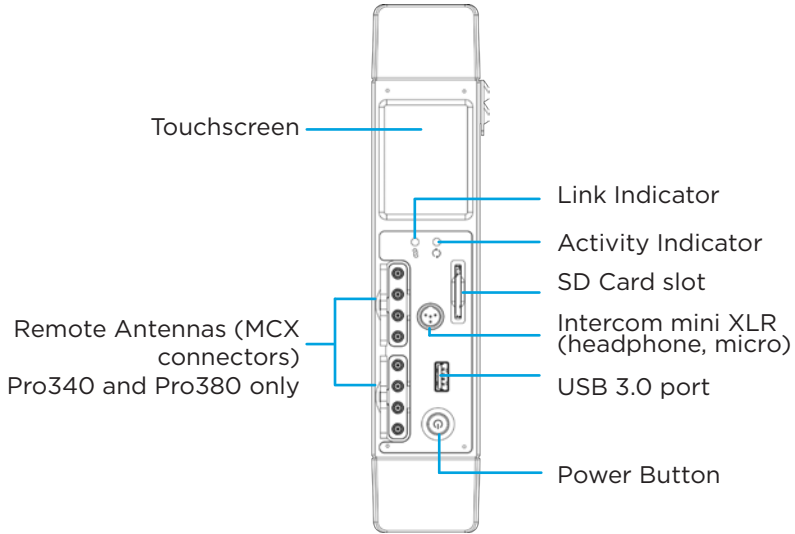

## Rear View

---

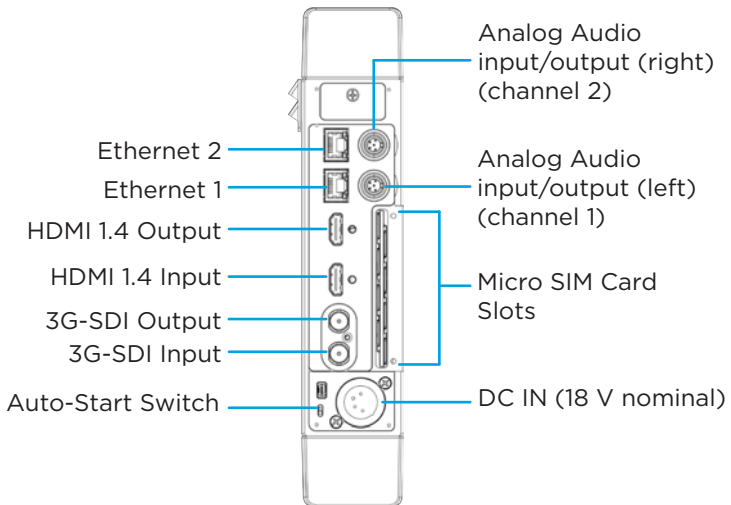

## Left and right sides

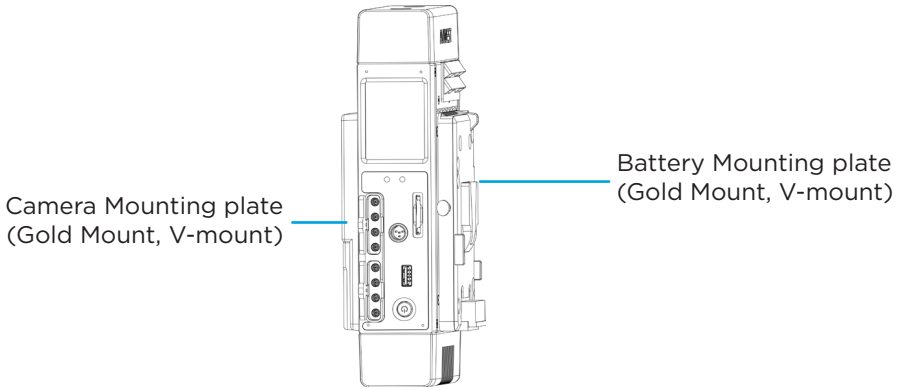

## Getting ready

1. Install an external battery onto the unit or connect the AC/DC adapter to the unit.

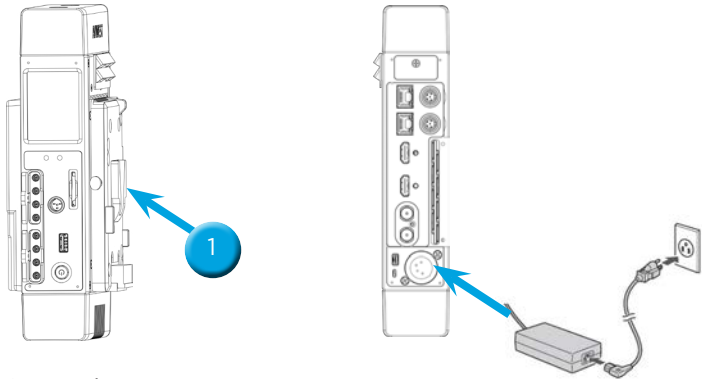

2. Insert a SD card

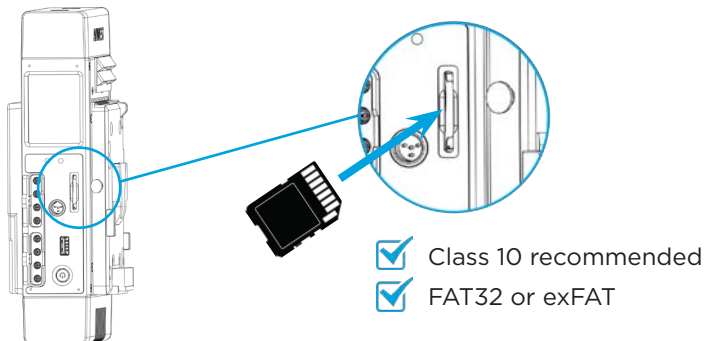

3. Insert SIM cards into slots.

 Micro SIM cards required.

a) Remove the SIM card cover.

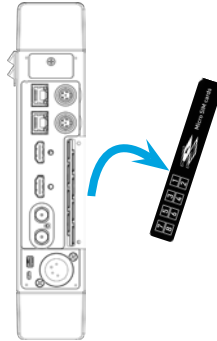

b) Insert SIM cards according to indications on cover.

For Pro340



For Pro360-5G



For Pro380

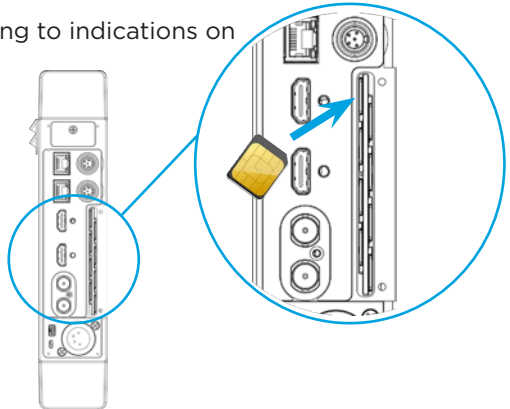

When using the unit in the USA, we recommend inserting SIM cards as follows:

SIM slot Number	US Operator
1	AT&T
2	T-Mobile
3	Verizon
4	AT&T
5	T-Mobile
6	Verizon
7	AT&T
8	T-Mobile

c) Place the rear cover back.

4. Connect the video input cable (either HDMI or SDI).

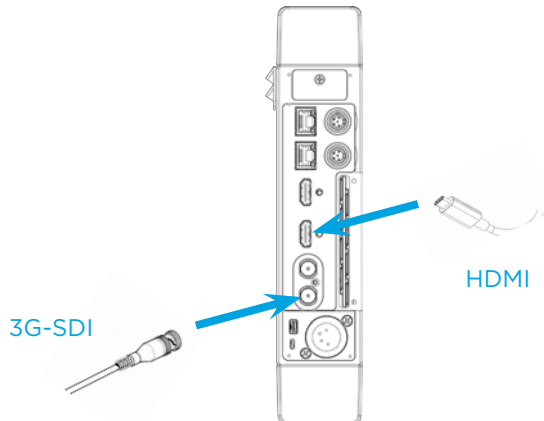

## Turning on the unit

---

Press the power button to turn the unit on.

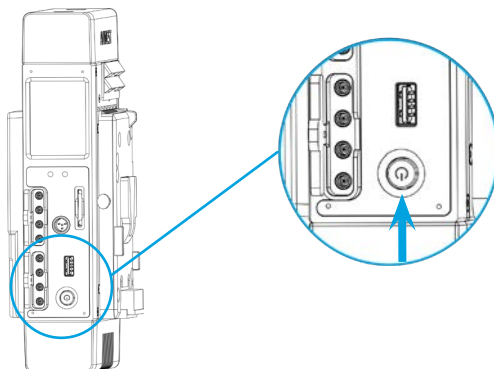

When the unit is ready, the Home screen appears:

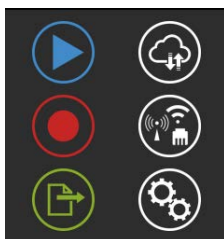

## Selecting a Video Source

---

1. From the Home menu, click on .

2. Click on .  
⇒ The default source is Auto.



3. Check that video source is Auto.

4. If not (SDI, HDMI or Pattern), click on the Video source Field and select the needed source.

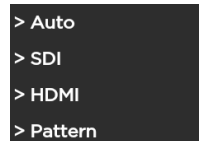

## Configuring a Destination Profile

---

1. Click on  and on  to access the DESTINATION PROFILE CONFIG menu.  
⇒ By default no profile exists.



2. Click on  to create a Destination Profile.

3. Click on the Profile Name field.

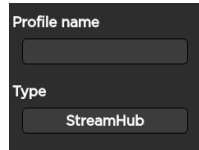

4. Use the keyboard to enter the new Profile name.



5. Click on  .

6. Click on  to configure the Profile settings:

⇒ Select StreamHub as Host type and set the corresponding IP address.

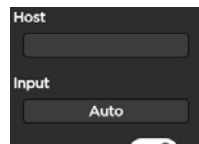

7. Click on  to save the new Destination Profile.

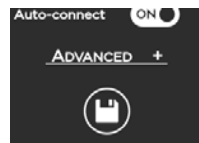

## Starting a Live

---

1. From the Home menu, click on .



2. Click on  to go to the LIVE menu.

The LIVE menu displays information:

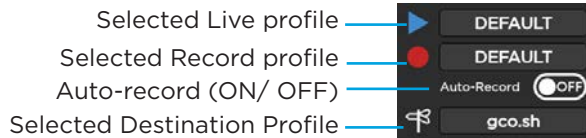

3. Click on  and on  to start a Live.

4. Click on  for more indications.

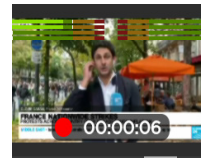

Some indications are displayed:

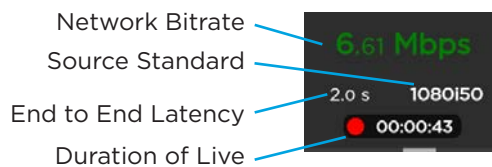





When Auto-record is enabled, additional indications appear:

Remaining Recording Time possible on SD card

Space used on SD Card

Duration of Live

## Stopping a Live

1. Click on

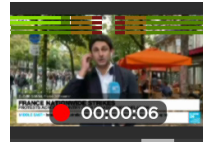

2. Click on



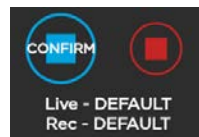

3. Click on



## Starting a Record

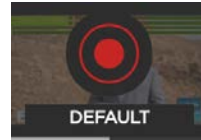

1. From the Home menu, click on .

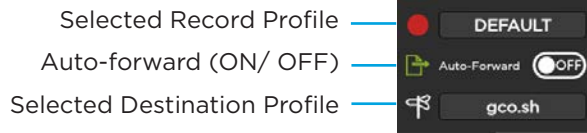

2. Click on  to go to the RECORD menu.

The RECORD menu displays information:



3. Click on  and on  to start a Record.

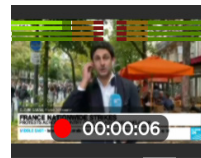

4. Click on  for more indications.

Some indications are displayed:

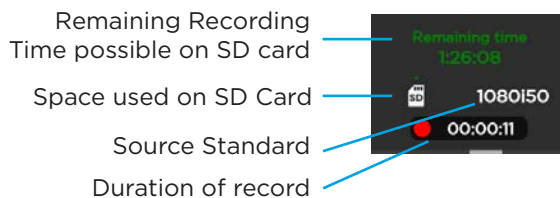



In case of a Record and Forward, additional indications appear:

Network Bitrate — 3.45 Mbps

Amount and percentage of data already forwarded — 9.7 MB - 39%

Duration of record — 00:00:18

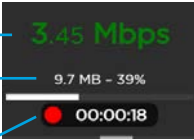

## Stopping a Record

---

1. Click on .

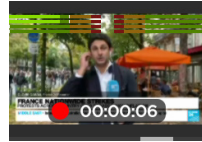

2. Click on .

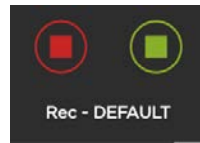

3. Click on .



## Starting a Forward

---

1. From the Home menu, click on .

The Forward menu appears:



2. Select a type of Forward.

To forward the last record:

Click on .



To forward all files:

a) Click on .



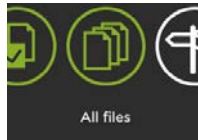

b) Click on .

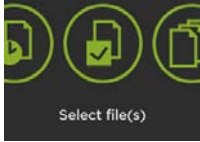

To forward some specific files:

a) Click on .



b) Click on .

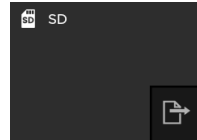

c) Click on files to be forwarded.

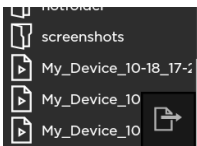

d) Click on .



During forward, some indications are displayed:

Number of files still to be forwarded —

Network Bitrate — **23.8 Mbps**

Amount and percentage of data already forwarded — 10.1 MB - Validating

Duration of forward — **00:00:08**

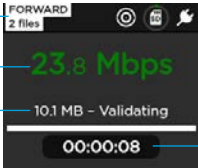

## Stopping a Forward

---

1. Click on .

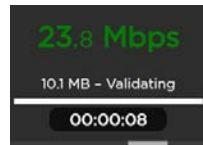

2. Click on .

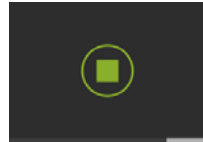

3. Click on .



## Turning off the unit

---

Long press the power button to turn the unit off.

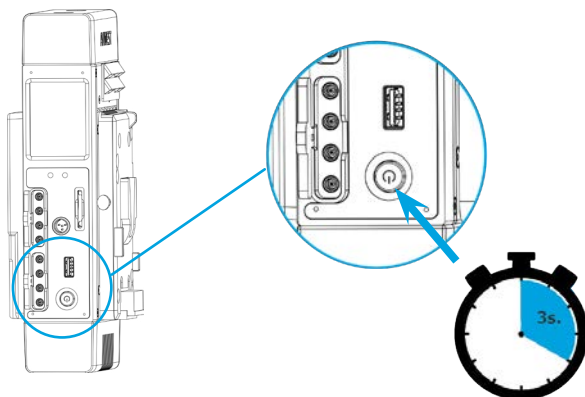

## All technical documents

---

Find the user guide and all other technical documents on Haivision Info Center at <https://doc.haivision.com>.

